



**Vibro**

Where ground improvement begins

# Overview of deep vibro techniques



## The subsoil

Soil conditions are usually described in a soil investigation report. If the properties do not fulfil the design requirements, deep vibro techniques offer an economical solution for ground improvement and can be carried out to almost any depth.

## The depth vibrator

The cylindrical depth vibrator is typically between 3m and 4m long and weighs approximately 2 tons. The core element of the vibrator is an electrically driven eccentric weight which induces the horizontal oscillation of the vibrator. The vibrator string is assembled with the vibrator and extension tubes to suit the improvement depth and suspended from a crane or mounted on a custom-built rig (e.g. the Keller Vibrocat).

## The techniques

The depth vibrator is used for three distinct techniques which differ in both their soil-improvement and in their load-transfer mechanisms. This range of techniques can provide solutions for a variety of ground conditions and structural applications. Keller

are able to advise on the most appropriate technique and often works with the consultant's geotechnical and structural engineers to develop the foundation solution.

The Vibro replacement technique is widely used in the UK. It forms load-bearing columns made from gravel or crushed stones in cohesive soils, and in granular soils with a high fines content.

The Vibro compaction technique compacts granular soils with negligible fines content by re-arranging the soil particles into a denser state.

Vibro concrete columns create structural foundation elements in the ground which will allow comparatively high loads to be safely carried by soils where no adequate lateral support for Vibro replacement columns can be mobilised.

## The process

The vibro process starts with the penetration of the oscillating depth vibrator into the ground to the required improvement depth. Subsequently, the vibrator is withdrawn as required by the employed technique to either compact the soil from the bottom up, or to construct a stone or concrete column.



# Overview

Deep vibro techniques offer flexible solutions for ground improvement. They are mainly used under foundations and floor slabs of structures to be built on soils of low or unreliable bearing capacity. Keller developed the depth vibrator (patented in 1934), which was originally used to compact granular soils such as sand and gravel. Today, Keller improves a variety of granular and cohesive soils employing a range of depth vibrator models and techniques.

## The benefits

Deep vibro techniques present a very versatile ground improvement method that can be adjusted to a wide variety of soil conditions and foundation requirements. Execution is comparatively fast even if large areas of site are to be improved, and subsequent structural works can follow very quickly. The ground improvement enables the contractor to utilise standard shallow footings which, in turn, leads to additional savings.

There are also environmental benefits from using vibro techniques. Keller's purpose-built lightweight rigs enable the construction of thinner working platforms; recycled materials are used where possible and vibro techniques usually generate less spoil. These all contribute to a reduced carbon footprint.

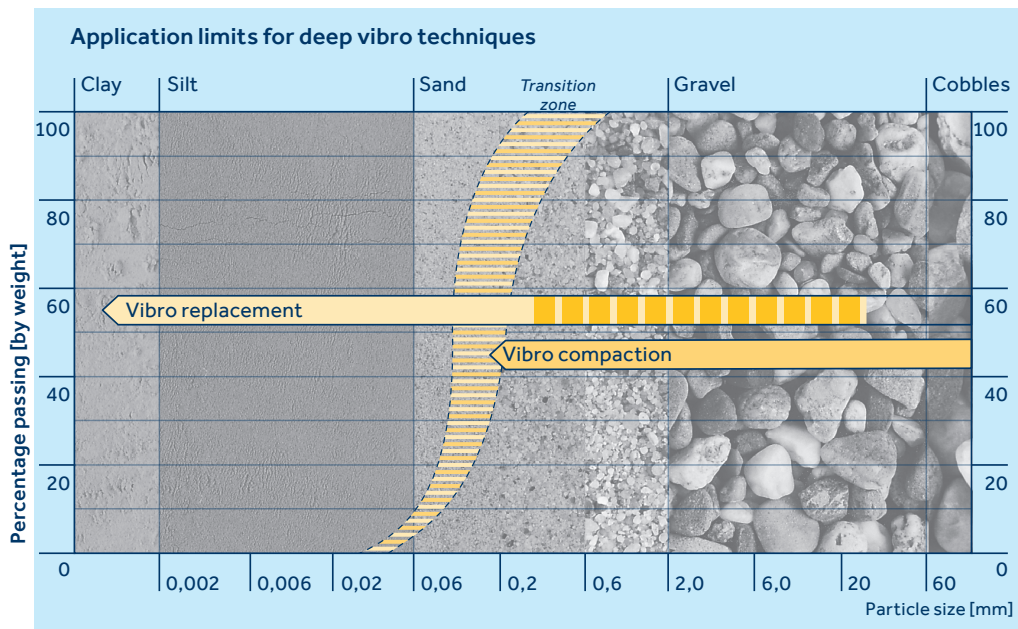

## Operating principle

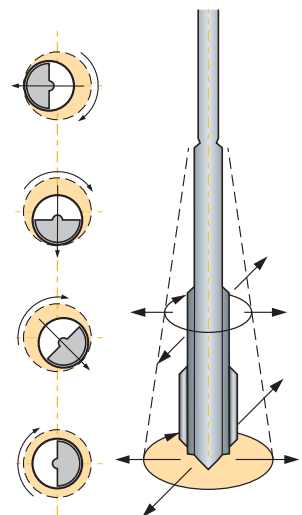

# Vibro replacement

## Equipment and process

The top feed process is frequently adopted to construct vibro replacement stone columns where coarse granular material is guided from the working platform level into the open hole formed by the vibrator. In soils where an open hole cannot be formed to the required depth, the bottom feed process is deployed, which feeds coarse granular material to the tip of the vibrator with the aid of pressurised air. To optimise the performance of this process and to accommodate the specialised equipment, Keller has developed the Vibrocat and Minicat base units which guides the vibrator on its leader and allows additional pull-down pressure to be exerted during penetration and compaction. The Vibro replacement process consists of alternating steps. During the retraction step, gravel runs from the vibrator tip into the annular space created and is then compacted and pressed into the surrounding soil during the subsequent re-penetration step. In this manner stone columns are created from the bottom up, and these behave as a composite material with the surrounding soil under load.

## Geotechnical aspects

Where compaction can be achieved in mixed or fine-grained soils through horizontal vibration and soil displacement (which depends mainly on their degree of saturation), this improvement should be evaluated in the same manner as vibro compaction. The pure vibro replacement process, however, does not assume any compaction in the surrounding soil. The improvement relies on the greater stiffness and higher shear strength of the stone column as well as the annular zone.

## The design concept

Keller has developed a reliable design method which uses the geometry of the columns and the friction angle of the column material as input parameters. For the foundation design, the improved ground is treated like normal subsoil. The allowable bearing pressure achieved after the improvement is typically in the range of 100 to 200kN/m<sup>2</sup>.

Design diagram for vibro replacement

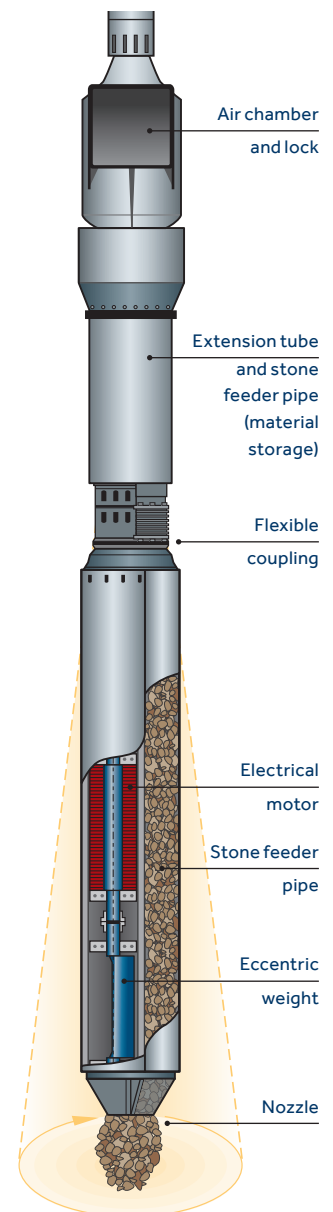
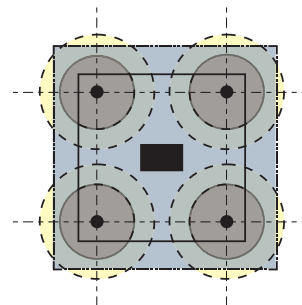
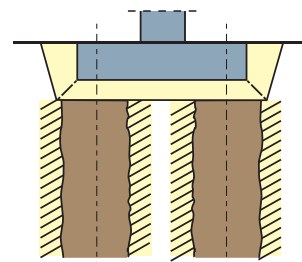
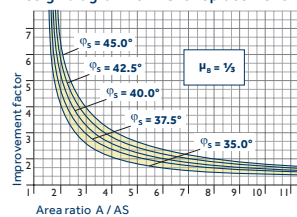



# Technical highlights

The vibro replacement technique builds load-bearing columns made from gravel, crushed stones or approved recycled materials in cohesive soils, and in granular soils with a high fines content.



## The bottom feed process

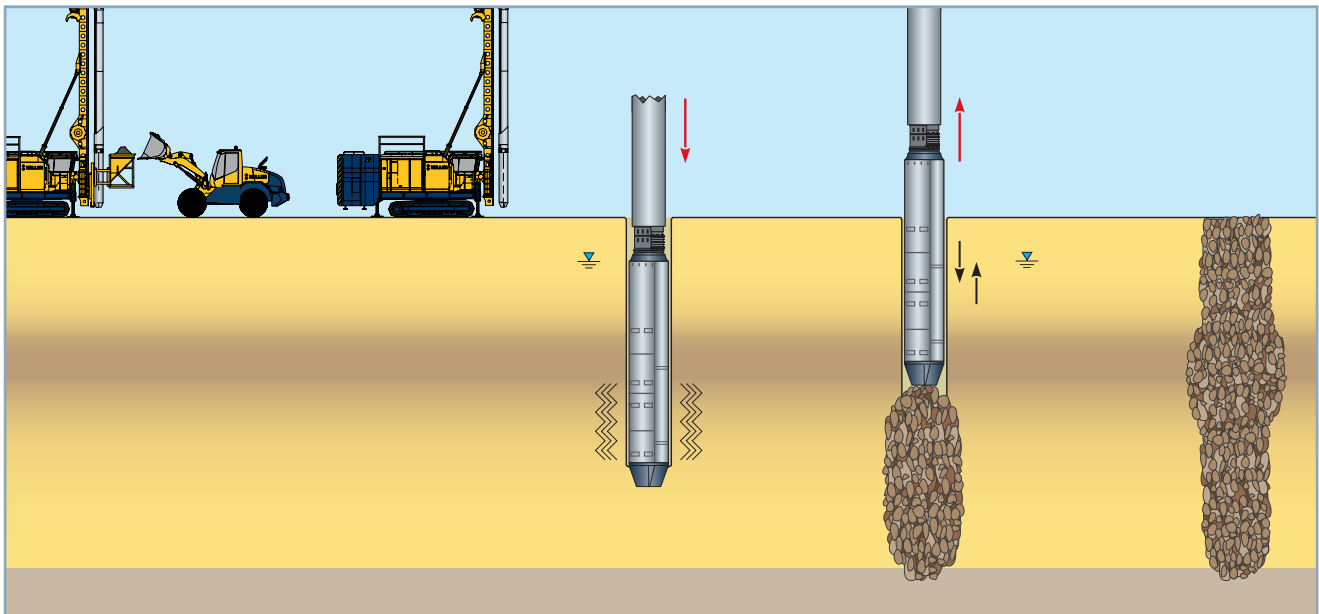

### 1. Preparation

The Vibrocat positions the vibrator over the required location of the compaction point and stabilises itself using hydraulic supports. A wheel loader fills the skip with aggregate.

### 2. Charging

The skip is lifted and empties its contents into the air chamber. Once the air lock is closed, the material flows towards the vibrator tip assisted by pressurised air.

### 3. Penetration

The vibrator displaces the soil and penetrates to the design depth, aided by the compressed air and by the Vibrocat's pull-down pressure.

### 4. Compaction

After reaching the maximum depth the vibrator is pulled up slightly, causing the aggregate to fill the cavity created. During re-penetration the aggregate is compacted and pressed into the surrounding soil.

### 5. Finishing

The stone column is built up in alternating steps to ground level, forming a column of highly compacted stone.



## The top feed process

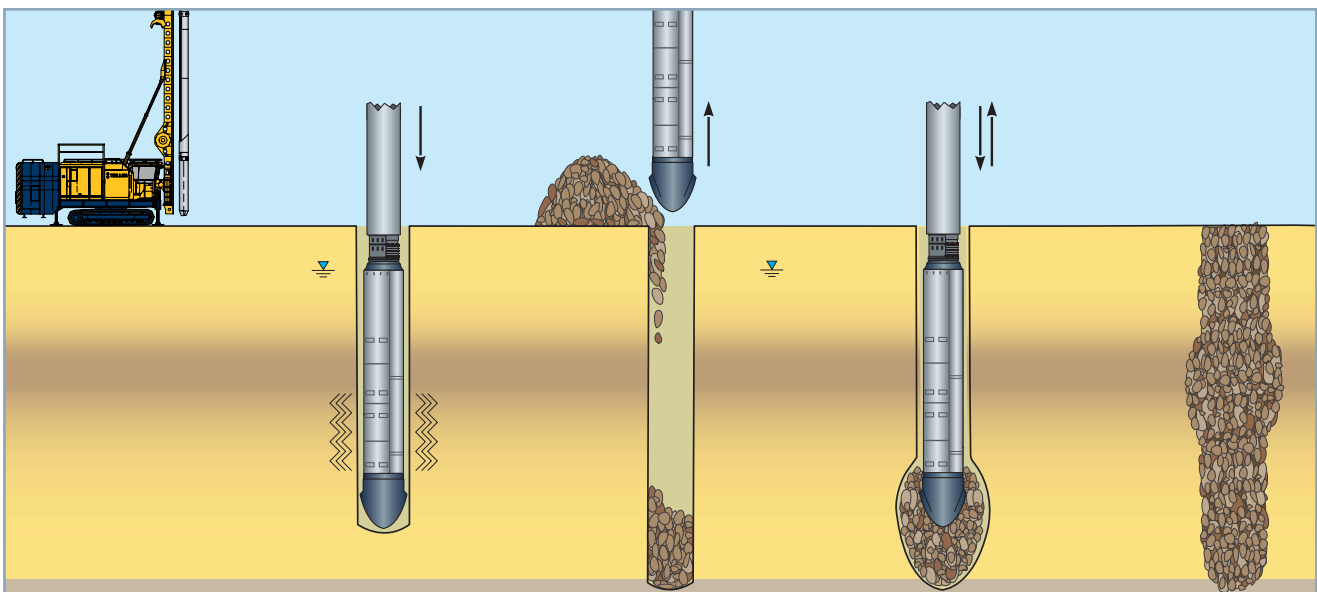

### 1. Preparation

The Mincat positions the vibrator over the required location of the compaction point and stabilises itself using hydraulic supports.

### 2. Penetration

The vibrator displaces the soil and penetrates to the design depth, aided by the compressed air and by the Mincat's pull-down pressure, forming an open bore to design depth.

### 3. Withdrawal

After being held at depth for a short time, the vibrator is withdrawn and a charge of stone is guided into the hole,

### 4. Compacting

The vibrator is reintroduced into the hole, the stone is compacted and forced outwards to tightly interlock with the surrounding ground.

### 5. Finishing

By adding successive charges of stone and compacting each layer, a column of highly compacted stone is built to ground level.

## Benefits of vibro replacement

- Reduces foundation and floor slab settlement
- Increases bearing capacity, allowing reduction in footing size
- Increases shear strength
- Allows quick drainage of excess porewater
- Increases stiffness
- Mitigates liquefaction potential
- Permits construction infills
- Permits shallow footing construction



# Vibro compaction

## Equipment and process

The compaction of granular soils is most economically realised with vibrators oscillating at a comparatively low frequency to achieve optimum compaction of the soil particles. The vibrator is typically suspended from a crawler rig or crane. The penetration of the vibrator, and to a certain extent the compaction process, is aided by water flushing with jets of variable pressures. The pressure pipes and jets form an integral part of the vibrator string. The compaction is carried out from the lowest point of penetration upwards in predetermined pull out steps and compaction intervals. The compaction result is dependent on the effectiveness of the vibrator and the soil conditions.

## Geotechnical aspects

Under the influence of the induced vibration, the soil particles within the zone of influence are rearranged and compacted. The extent of this zone depends on the vibrator used, the soil, and the method employed. The volume reduction of the compacted soil can reach values of the order of 15 % depending on the soil conditions and the intensity of the compaction effort.

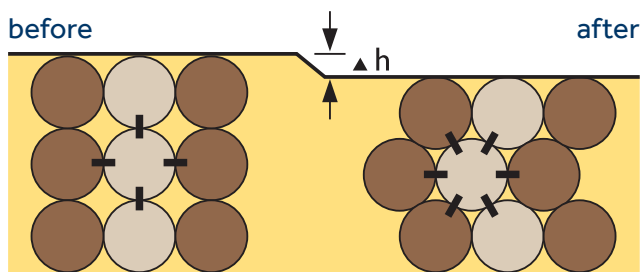

## The design concept

The spacings between the compaction points are governed by several parameters. Keller are able to draw upon a wealth of experience to propose

suitable grids. However, the optimum arrangement of the vibro compaction points is best achieved by an on-site trial, where different compaction grids and methods can be tested and evaluated.

The layout of the compaction points can be adjusted so that soil volumes of any size are compacted. The achieved degree of compaction can be easily and economically verified using a range of different tests.

Compaction below raft footings

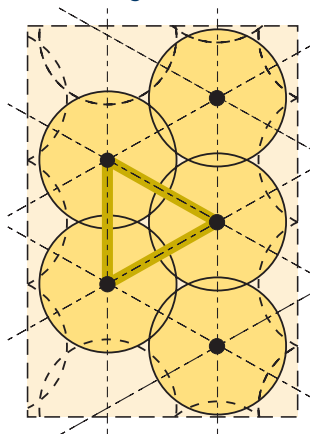

Compaction below single footings

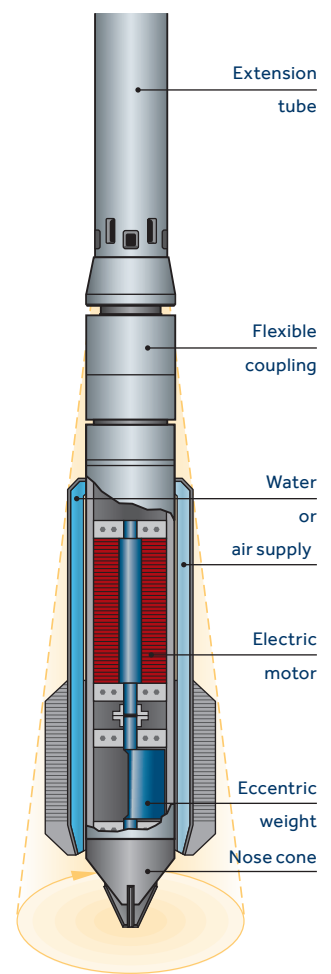
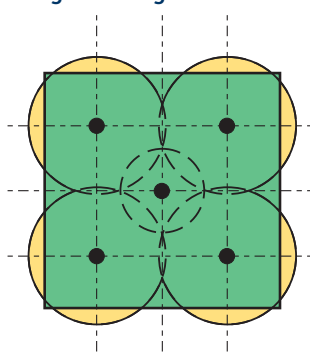

# Technical highlights

The vibro compaction technique compacts granular soils with negligible fines content by re-arranging the soil particles into denser state.



## The process

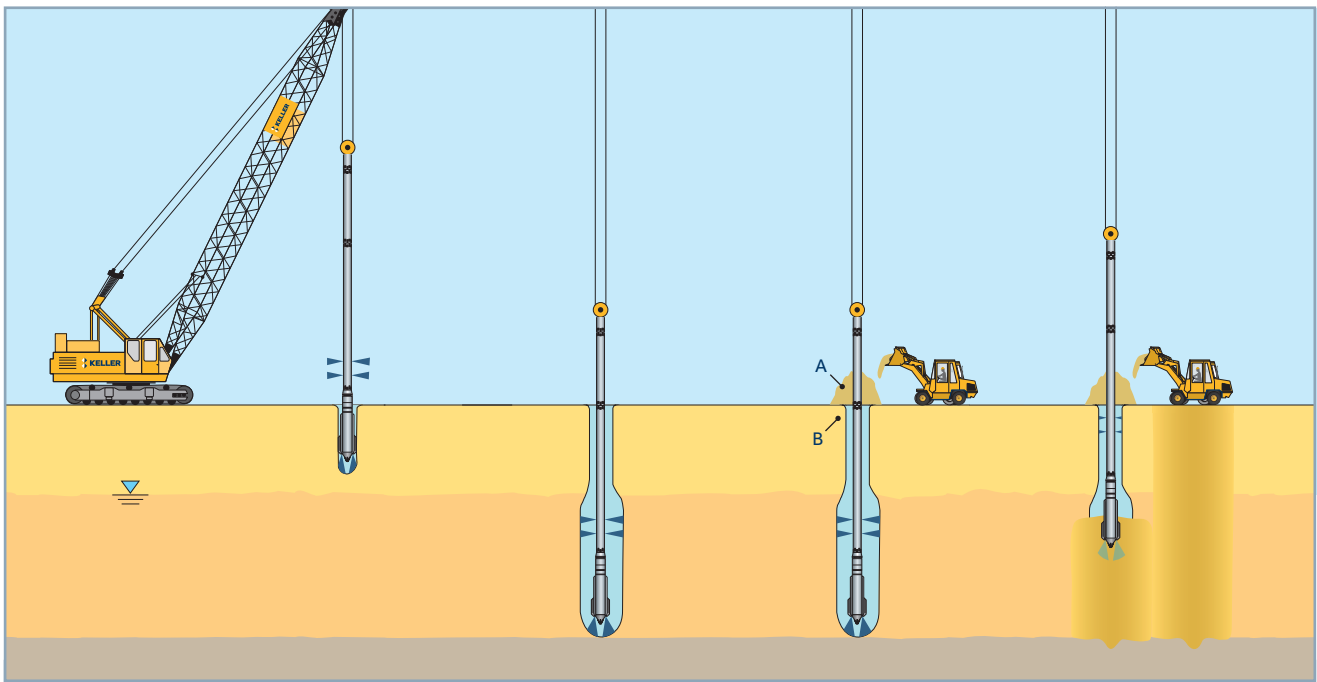

### 1. Penetration

At full water pressure the oscillating vibrator penetrates to the design depth and is surged up and down as necessary to agitate the granular soil, remove fines and form an annular gap around the vibrator. At full depth the water flow is reduced.

### 2. Compaction

The compaction is carried out in steps from the maximum depth of penetration upwards. It encompasses a cylindrical soil body of up to 5 m diameter. The increase in density is indicated by a rise in power consumption of the vibrator.

### 3. Backfilling

Around the vibrator a crater develops which is backfilled with sand, which is either imported (A) or taken from the existing soil (B). For this purpose a volume of up to 15 % of the treated soil volume is required.

### 4. Finishing

After completion of the compaction, the surface is re-levelled and compacted with a vibratory roller.

## Benefits of vibro compaction

- Reduces foundation settlement
- Increases bearing capacity, allowing reduction in footing size
- Increases stiffness
- Increases shear strength
- Can reduce permeability
- Mitigates liquefaction potential
- Provides slope stabilisation
- Permits construction in fills
- Permits shallow footing construction
- Prevents earthquake-induced lateral spreading



# Vibro Concrete Columns (VCC)



## Equipment and process

Vibro concrete columns typically consist of pumpable, C25/30-strength concrete. The toe of the column is enlarged by repeated retraction and re-penetration of the vibrator, but the shaft is built in a single pull due to the high internal strength of the concrete.

## Geotechnical aspects

During the installation of vibro concrete columns no particular effort is made to densify any specific soil layer. As with other structural foundation elements, a high degree of improvement can be achieved at the toe of the column, and this leads to a particularly high bearing capacity and low deformations under load.

## The design concept

Vibro concrete columns are generally more slender compared to other structural foundation elements. Typical shaft diameters range between 400mm and 600mm. The bearing capacity under working load can reach 750kN depending on the ground conditions and on the extent to which the toe can be enlarged.

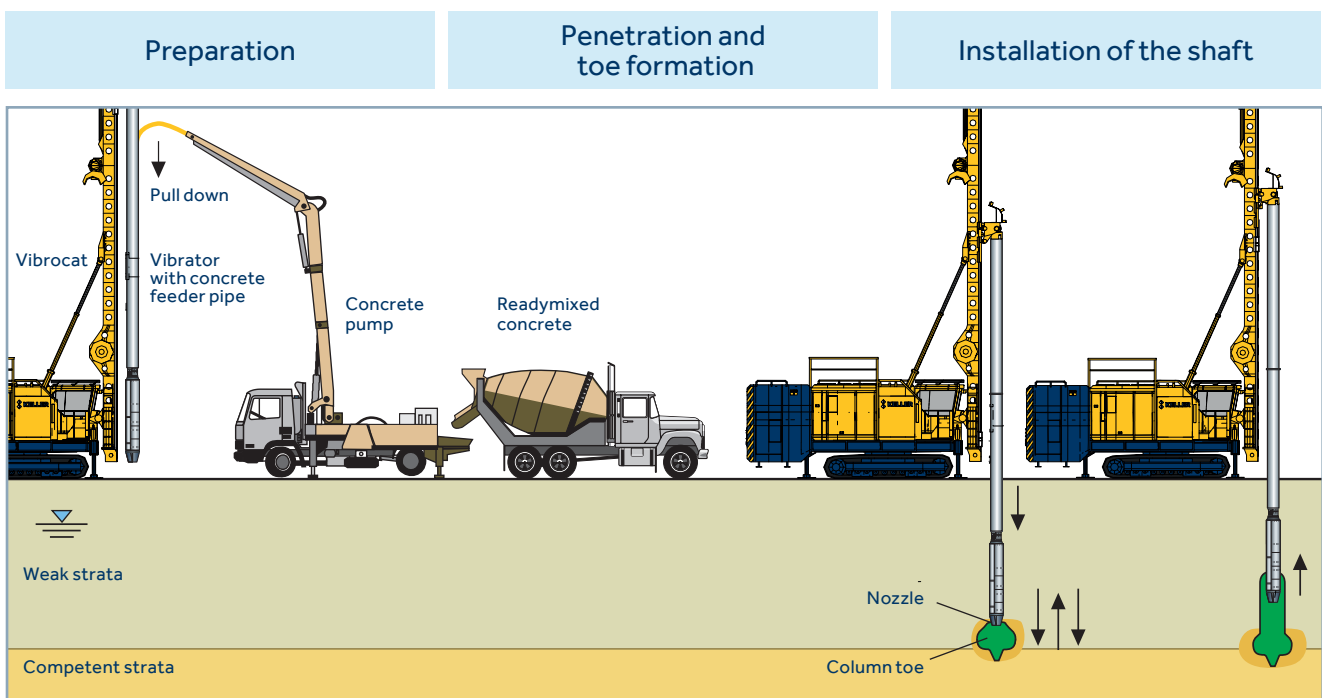

# Quality control

For all vibro techniques, electronic measuring devices can be employed to ensure and record constant high quality of workmanship. Testing is usually undertaken on completion.



## The measurement results

During compaction a number of different site and production parameters are automatically recorded. Values such as time, depth, penetration/pullout speed, pull-down force and current can be graphically displayed and printed. If required, the energy consumption can be recorded.

These parameters can be viewed remotely by Keller, which is of huge benefit, particularly for close monitoring of vibro operations on challenging sites.

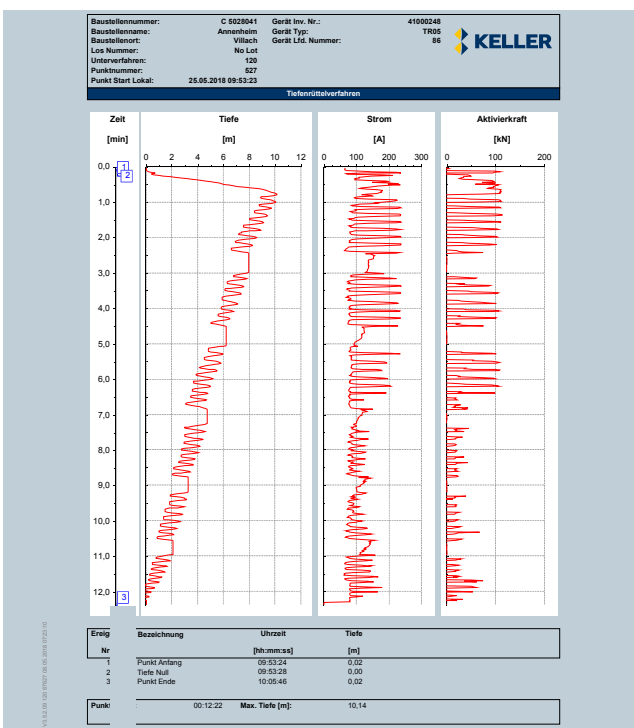

## Testing

Plate load tests are commonly undertaken to verify the workmanship of individual stone columns. The performance of the improved ground can be tested by zone tests or dummy footing tests. Dummy footing tests are commonly adopted as a relatively quick and easy testing method.





# Case Study

## REnescence Bio Plant, Northwich, Cheshire

Dong Energy built the world's first bio plant of its kind using their REnescence technology to treat household waste through the use of enzymes. Keller was asked to devise a ground improvement solution that catered for the varying site conditions and treatment depth and keep to a demanding 19-week works timetable.

Keller offered a top feed Vibro replacement support system to achieve safe bearing pressures ranging from 50kN/m<sup>2</sup> up to 150kN/m<sup>2</sup> for the main building,

6 no anaerobic tanks and other site structures. Pre-boring was adopted to assist penetration of the vibrating poker to the natural weaker strata that required stabilisation.

The design depths varied between 2.5m and 6.0m to suit the varying site conditions, stopping in the competent natural strata of stiff sandy gravelly clay. Keller completed the 5,900 No. stone columns in 3 No. phased visits, using 2 No. Minicat Vibro rigs and 2 No. pre-boring rigs.





## Keller UK

Geotechnical solutions specialist  
Oxford Road,  
Ryton-on-Dunsmore,  
Coventry,  
CV8 3EG.

w: [keller.co.uk](http://keller.co.uk)  
e: [foundations@keller.co.uk](mailto:foundations@keller.co.uk)  
t: 02476 511266

# Case Study

## Oakgrove Residential Development, Milton Keynes

At the site of a former shallow gravel pit on the southern fringe of Milton Keynes, Crest Homes developed approximately 1000 homes. The site was formerly treated by Dynamic Compaction in the 1990s. However, levels were to be raised and no validation of the previously treated soils was available. Levels were raised with engineered clay fill by up to 2m in thickness, though typically 1.0-1.5m.

The geology consists of loose previously worked alluvial gravels underlain by stiff Oxford Clay. The Keller treatment scheme decided upon for the vast majority of the site was vibro stone columns to treat the alluvial gravels so as to keep settlements less than 20mm from the top of the engineered fill.

Where perimeter trees were present, driven precast piles were installed as the depth of foundations would otherwise have been excessive. Elsewhere, the design necessitated preparing calculations to show that after treating both the new fill and relic fill settlements could still be kept to less than 20mm.

Keller have undertaken four phases installing nearly 10000 stone columns at the site. An additional phase was carried out to treat beneath a Waitrose store.